

# **IMPULSE FOOT SEALER**

**305FD, 455FD, 605FD**

**3010FD, 4510FD, 6010FD**

## **INSTRUCTION**

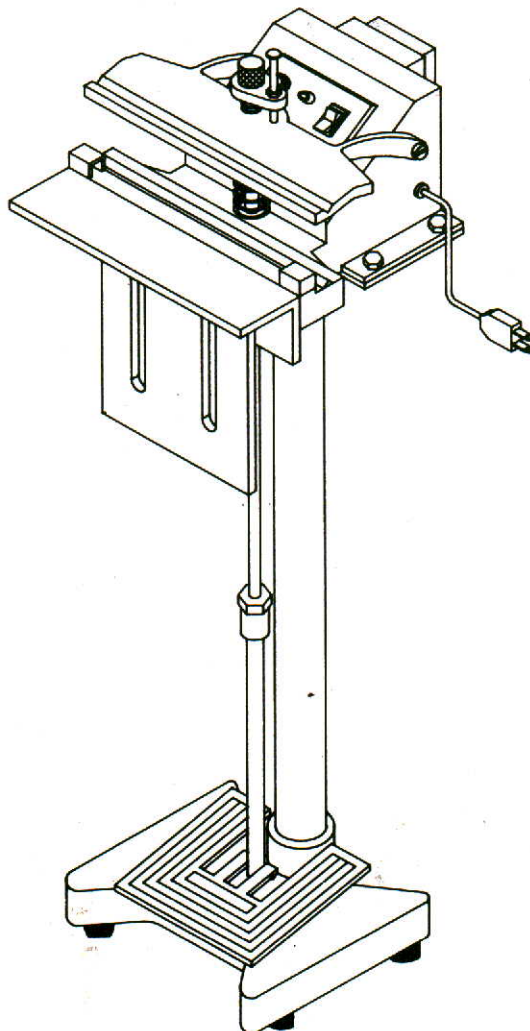

# 1 CONSTRUCTION DIAGRAM

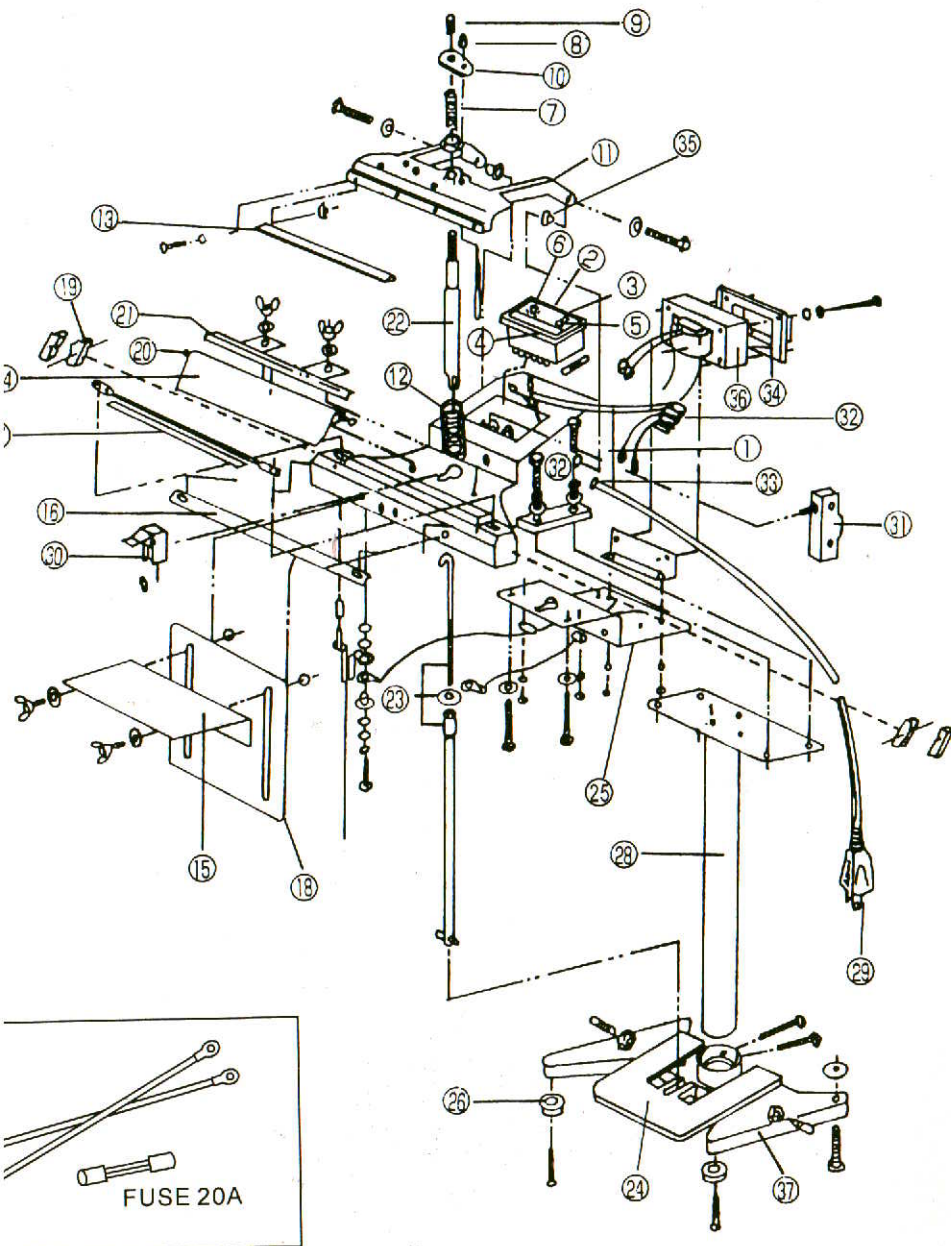

# 2 PARTS LIST

- 1. ENCLOSURE
- 2. TIMER CONTROL
- 3. PILOT LAMP
- 4. FUSEHOLDER
- 5. POWER SWITCH
- 6. TIMER KNOB
- 7. PRESSING SPRING
- 8. SETTING BOLT NUT
- 9. UPPER LEVER NUT
- 10. FIX PLATE
- 11. UPPER JAW
- 12. UPPER JAW SPRING
- 13. SILICONE RUBBER PAD
- 14. UPPER TEFLON CLOTH
- 15. WORKING PLATE
- 16. UPPER CLOTH FIX PLATE
- 17. LOWER HEATER CLOTH
- 18. LEVEL PLATE
- 19. HEATING TERMINAL ASSEMBLY
- 20. METAL BAR FOR CLOTH
- 21. CLIP FOR TEFLON CLOTH
- 22. UPPER LEVER
- 23. DOWN LEVER
- 24. FOOT PEDAL
- 25. BOTTOM COVER PLATE
- 26. RUBBER FOOT
- 27. RELAY
- 28. STANDING TUBE
- 29. POWER SUPPLY CORD
- 30. INTERLOCK SET
- 31. LIMITED SWITCH
- 32. CONNECTOR
- 33. STRAIN RELIEF BUSHING
- 34. TRANSFORMER COVER
- 35. HINGE FOR UPPER JAW
- 36. TRANSFORMER
- 37. PEDAL BASE

# 3 CONNECTION DIAGRAM

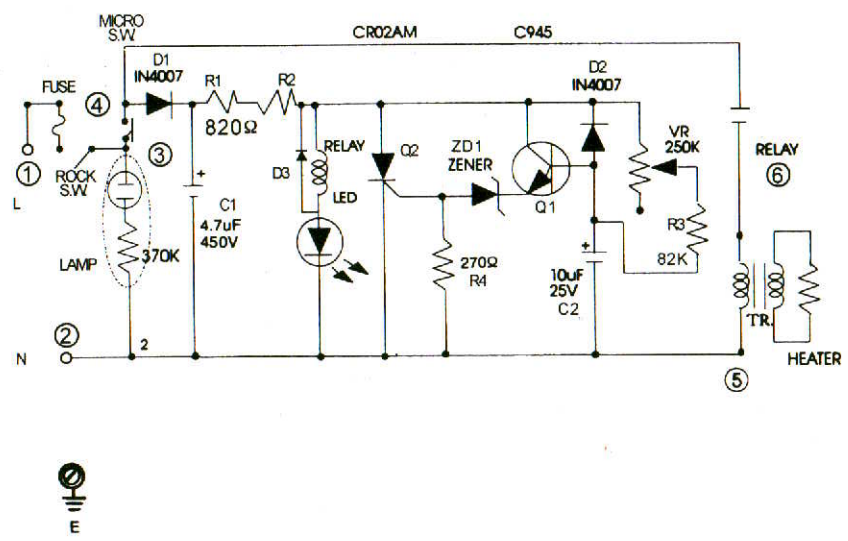

## 4 HELPFUL INFORMATION

- Always keep the sealing platform clean. Particular care 'should' be taken to remove any residue from the teflon tape.
- Do not clean the sealing platform with anything wet.
- Make sure to change the upper teflon tape (above the element wire) and the lower teflon strip (below the element wire) when they become worn. If this is not done, the element wire may short out and become damaged.
- When replacing the heating element always check the condition of the bottom teflon tape. It is important that you replace the element wire only with the one made for this machine. You can damage the transformer with the wrong element wire.
- Occasionally check the condition of the top pressure pad (silicon rubber) for wear or burn. A poor rubber pad will effect the quality of your seal.

USE ONLY GENUINE REPLACEMENT PARTS

## 5. CHANGING PARTS

To replace burnt out teflon tape or broken element wires please follow these instructions:

REMOVE PLUG FROM ELECTRIC OUTLET.

1. To replace Teflon
  - (a) Remove pressing plate. Loosen teflon clips.

- (b) Pull out teflon tape just enough to cut off burned area. Smooth out teflon and refix the pressing plate.
  - (c) Rotate teflon screw to pull teflon tight. Retighten the teflon clips.

### 2. Replacing heating element wire

- (a) Loosen teflon clips. Remove pressing plate.
- (b) Lift up teflon and remove broken element wire from element locks.
- (c) Put new element wire on element locks. Do not bend or crimp the wire.
- (d) Replace teflon and pressing plate. Tighten teflon with teflon screw. Tighten teflon clips.

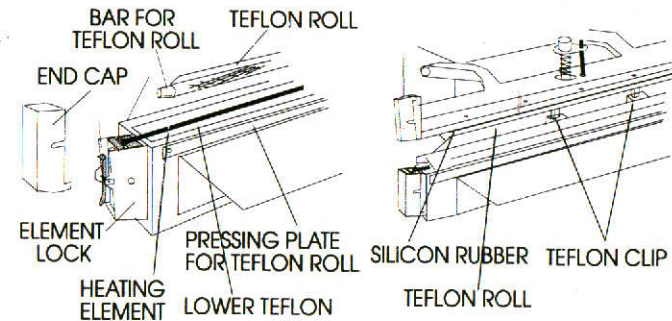

## 6 CAUTIONARY MARKINGS

- CAUTION** -To reduce the risk of shock, disconnect the unit from the supply circuit before servicing the replacement of the heating element.
- To provide continued protection against risk of electric shock connect to properly grounded outlet only.
  - A live heating element is located in the arm under the teflon. Use caution during operation. DO NOT TOUCH THE ELEMENT.
- WARNING** -For Continued Protection Against Fire or Electric shock, Replace Only With Type Cartridge and 20 Ampere Fuse. Provided in legible adjacent to fuseholder.

## 7 ASSEMBLING FOR FOOT SEALER

(1). Insert standing tube into pedal base and connect with short screw.

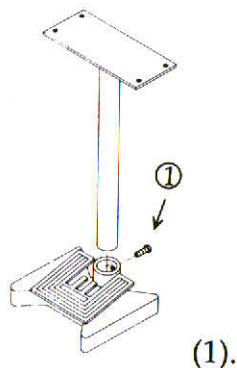

(2). With four long screws connect body to stand.

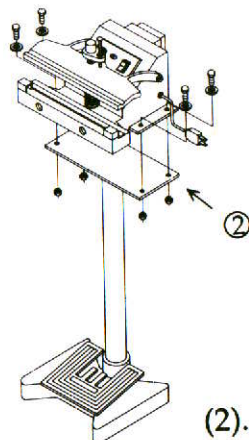

(3). Attach puller rod to puller (located under base) and then attach to foot pedal.

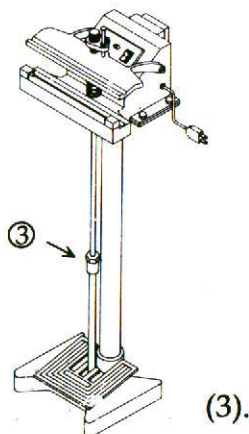

(4) & (5) Connect working plate fixed bracket to body. Fit working plate over bracket.

Note: When attaching working plate bracket leave enough space between sealer body and top of screws so that working plate can be attached easily.

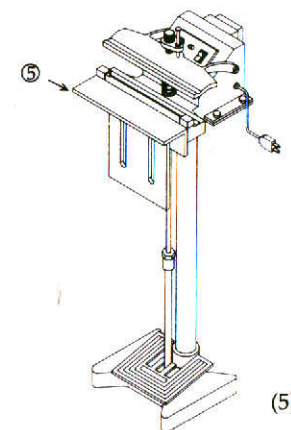
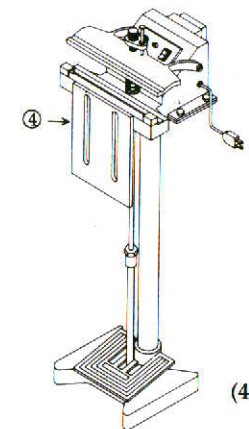

## 8 OPERATING INSTRUCTIONS

After the machine is fully assembled and plugged into a outlet, do the following:

1. Adjust the foot pedal rod (#23 down lever) to obtain a firm contact of the jaws.
2. Push the on / off switch(#5) to ON position.
3. Turn the timing knob(#6) to the lowest number and press the foot pedal down. The little neon light(#3) will go on for less than a second, this is the sealing time. Hold the pedal down for another second, this is the cooling-down time.
4. If it does not complete with the seal, turn the timing knob up a little and go through process in 3. Keep increasing the number until you get the desired seal. Then leave it alone.
5. FOR SAFETY SAKE" KEEP HANDS AND FINGERS FROM BETWEEN THE JAWS WHEN SEALING.

TURN MACHINE OFF WHEN NOT IN USE.

## 9 SPECIFICATIONS

Model	305/3010FD	455/4510FD	605/6010FD
Source	120V-240V	120V-240V	120V-240V
Power	1500/2000W	2000/2500W	2500/3000W
Seating Time	0.3-1.5SEC	0.3-1.5SEC	0.3-1.5SEC
Max Seal Thickness	0.8mm	0.8mm	0.8mm
Max Seal Length	300mm	450mm	600mm
Weight	58 lbs	62 lbs	66 lbs
Dimension (inch)	17x17x15x29.5	17x17x15x29.5	17x17x15x29.5

No.	Description	Part Number
1	ENCLOSURE	*BODYAFI
2	TIMER CONTROL	*TI-FD
3	PILOT LAMP	
4	FUSE HOLDER	*FUSEBOX-F
5	POWER SWITCH	*ROCKSW
6	TIMER KNOB	*KNOB
7	PRESSING SPRING	*JAWSP-L1
8	SETTING BOLT NUT	*SE-BOLT
9	UPPER LEVER NUT	*PULLER
10	FIX PLATE	*PLATE#10
11	UPPER JAW	*JAW-AFI
12	UPPER JAW SPRING	*JAW-L
13	SILICONE RUBBER PAD	*SR450FD
14	UPPER TFLON CLOTH	*TFS450
15	WORKING PLATE	*TA410FD
16	UPPER CLOTH FIX PLATE	
17	LOWER PTFE	*TFL410FD
18	LEVEL PLATE	*LEVELP
19	HEATING TERMINAL ASSEMBLY	*CAPSETFD
20	METAL BAR FOR CLOTH	*TFSB410F
21	CLIP FOR TEFLON CLOTH	*CLIP410F
22	UPPER LEVER	*ROD
23	DOWN LEVER	*ROD
24	FOOT PEDAL	*PEDAL-F
25	BOTTOM COVER PLATE	
26	RUBBER FOOT	*FOOT-F
27	RELAY	
28	STANDING TUBE	*STAND
29	POWER SUPPLY CORD	*COARD-AF
30	INTERLOCK SET	*INTLOCK
31	LIMITED SWITCH	*MICROF
32	CONNECTOR	*CONNECTF
33	STRAIN RELIEF BUSHING	*CORDHO-F
34	TRANSFORMER COVER	*TR410FD
35	HINGE FOR UPPER JAW	*FLANGE-F
36	TRANSFORMER COVER	*TRCOVERF
37	PEDAL BASE	*BASE
38		
39		
40	NOTE: SPECIAL SIZE	
41	*BODY-600FD/610FD/610FDA	
42	*TI-FD(OLD TYPE/NEW TYPE)	
43	*MICRO-AI/FI/FD	